

Distribution Box  
Intelligent fiber Box

照明配电箱  
光纤信息箱



**SINGI® 信基伟业**

建筑电气 & 智能家居集成商 **国家高新技术企业**

Building electrical & intelligent household integrator  
National high-tech enterprises



上海奉贤庄行欧洲工业园区的上海信基工业园  
Shanghai Singi Electrical Co. Ltd



浙江信基电气股份有限公司工业园  
Zhejiang Singi Electrical LLC

## 关于我们

### About Us

信基伟业始创于1995年,是目前国内知名的建筑电气&智能家居集成商;专业研发和生产智能光纤信息箱、墙壁式无线路由器、吸顶式无线路由器、电脑线、电视线、照明配电箱、小型断路器、家居安防线缆、开关插座等。

Singi Electric was established in 1995 and now become the well-known building electric integrator. Singi are professional in producing fiber information box, wall-type WIFI router, roof-type WIFI router, low voltage cables, circuit breaker, wall switch and etc.

#### 核心价值观:

- 以客户为中心;
- 以奋斗者为本,尊重个人,制度至上;
- 尽一切可能创新产品和管理;
- 正直、协作、效率、分享。

#### Core Values:

- Customer focus;
- Take the strivers as the foundation, respect the individual, and put the system first;
- Innovate products and management as much as possible;
- Integrity, collaboration, efficiency and sharing.

#### 核心使命:

- 聚焦客户所想,以信赖的品质,做用户电气安全的好伙伴;
- 让更多善良的人因公司的久远存续得到帮助。

#### Core Mission:

- Focus on customers' needs, and be a good partner for users' electrical safety with reliable quality;
- Let more kind-hearted people get help because of the long-term existence of the company.

#### 企业愿景:

提供客户称道的产品和服务,更提供安全和解决方案。

#### Enterprise Vision:

Provide products and services that customers praise, and provide security and solutions.

## 发展历程

### Development History

#### 企业成长期

- 1995年 | 信基电器厂(信基伟业前身)成立
- 1999年 | 与正泰集团、鸿雁电气结为战略合作联盟

#### 二次创业期

- 2001年 | 浙江信基电气股份有限公司、上海信基电气有限公司成立
- 2003年 | 与西蒙电气、霍尼韦尔朗能公司结为战略合作联盟

#### 跨越发展期

- 2006年 | 投资3800多万元的浙江乐清信基工业园建成并投入使用
- 2007年 | 投资2000多万元的上海奉贤信基工业园建成并投入使用
- 2009年 | 产品出口欧美、东南亚等地;产品使用于上海世博场馆建设

#### 企业腾飞期

- 2010年 | 举办“牵手姚明,共享未来”的品牌推广,年产值突破2亿
- 2011年 | 信基伟业商标被认定为“中国驰名商标”年产值突破2.7亿
- 2012年 | 与国内多家房地产集团建立战略合作关系,年产值突破3亿
- 2013年 | 信基伟业商标被评为“中国电工十大品牌”与“保障性安居工程推荐品牌”
- 2014年 | 公司通过ISO14000环境体系认证,公司产品由太平洋保险公司承保
- 2015年 | 公司通过OHSAS18001职业健康安全管理体系
- 2016年 | 信基携手CCTV强力助推,并获得“国家高新技术企业”称号
- 2017年 | 信基荣获“中国配电箱十大品牌”称号
- 2018年 | 信基荣获“中国房地产供应商高成长型企业”称号
- 2019年 | 国家高新技术企业顺利通过复评
- 2021年 | 建筑面积40000m<sup>2</sup>新厂房投入使用

#### Enterprise Growth Period

- In 1995, SINGI Electric Appliance Factory (predecessor of SINGI) was founded
- In 1999, it formed a strategic cooperation alliance with CHINT Group and HONYAR Electric

#### Second Entrepreneurial Period

- In 2001, Zhejiang SINGI Electric Co., Ltd. and Shanghai SINGI Electric Co., Ltd. were established
- In 2003, it formed a strategic cooperation alliance with SIMON Electric and Honeywell Lunergy

#### Leapfrog Development Period

- In 2006, Zhejiang Yueqing SINGI Industrial Park with an investment of more than 38 million yuan was completed and put into use
- In 2007, Shanghai Fengxian SINGI Industrial Park with an investment of more than 20 million yuan was completed and put into use
- In 2009, the products were exported to Europe, America, Southeast Asia and other places; The product is used in the construction of Shanghai World Expo venues

#### Enterprise Take-off Period

- In 2010, the brand promotion of "holding hands with Yao Ming and sharing the future" was held, and the annual output value exceeded 200 million
- In 2011, SINGI trademark was recognized as "China's famous trademark" with annual output value exceeding 270 million
- In 2012, it established strategic cooperative relations with many domestic real estate groups, with annual output value exceeding 300 million
- In 2013, the trademark of SINGI was rated as "Top Ten Brands of CNEEC" and "Recommended Brands for Affordable Housing Project"
- In 2014, the company passed ISO14000 environmental system certification, and its products were underwritten by Pacific Insurance Company
- In 2015, the company passed OHSAS18001 occupational health and safety management system
- In 2016, SINGI joined hands with CCTV and won the title of "National High-tech Enterprise"
- In 2017, SINGI won the title of "Top Ten Brands of Distribution Box in China"
- In 2018, SINGI won the title of "China's real estate supplier high-growth enterprise"
- In 2019, the national high-tech enterprises successfully passed the re-evaluation
- By 2021, a new plant with a building area of 40000 m<sup>2</sup> will be put into use

## 企业实力 Enterprise Strength

是目前国内专业生产建筑电气产品的高科技民营股份制企业,公司生产员工800多人,各种管理及技术人员100多人;各类大型生产、检测设备300多台,致力于智能家居、配电控制系统产品、照明控制系统产品、低压电器和安防线缆的研发、生产和销售。

At present, it is a high-tech private joint-stock enterprise specializing in the production of building electrical products in China. The company has more than 800 production staff and 100 management and technical personnel. Multiple people; More than 300 sets of large-scale production and testing equipment of various types are dedicated to smart home, power distribution control system products, lighting control system products, low-voltage electrical appliances and safety R&D, production and sales of anti-cable.

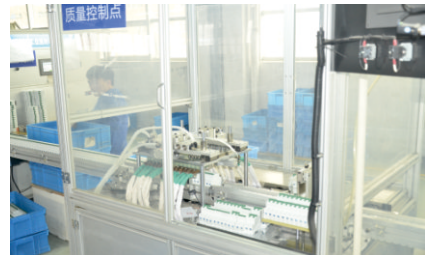

## 资质荣誉

### Honor Of Qualification

公司先后通过ISO9001、ISO14001、ISO45001国际管理标准三体系认证及UL、CE、CB、ETL等国际产品认证；拥有50多项专利，40多份CCC强制认证，获得“中国建筑电气知名品牌”“中国电工十大品牌”、“保障性家居工程推荐品牌”、“CCTV央视上榜品牌”、“国家高新技术企业”、“中国房地产供应商高成长型企业”等70多项荣誉。

Singi has passed ISO9001, ISO14001, ISO45001 international three system certification. Also get the international production certification of the UL, CE, CB, ETL and etc. Singi have over 50 copy rights, over 60 CCC certification. During the 20 years production experience, Singi get the over 70 titles such as “top 10 electric brand in China”, “Chinese building electric well-known brand”, “Government-subsidized housing project recommend brand” and etc.



- 国家高新技术企业  
National high-tech enterprises



- CCTV央视助推品牌  
CCTV boosts brand



- 产品责任保险证书  
Product liability insurance certificate



- ISO9001质量管理体系认证  
ISO9001 quality management system certification



- ISO14001环境管理体系认证  
ISO14001 Environmental Management System Certification



- ISO45001职业健康安全管理体系认证  
ISO45001 Occupational Health and Safety Management System Certification



- 50多份专利  
More than 50 patents



- 40多份CCC证书  
More than 40 CCC certificates



- 欧盟RoHS认证  
EU RoHS certification



- CE认证  
CE certification



- CB认证  
CB certification



- UL认证  
UL certification



- ETL认证  
ETL certification

## 工程案例 Engineering Template

多年来，SINGI信基，凭借卓越的品牌信誉和质量在竞争激烈的市场中开疆拓土，业绩斐然，产品销售网络覆盖国内各大中城市，在工程上广泛地得以应用。

在智能化信息化方面我们不断超越，在开发人性化产品的征途中，我们不遗余力，让SINGI信基的产品遍布世界每一个角落，是我们至高的追求目标。

Over the years, SINGI with its excellent brand reputation and quality, has expanded its territory in the highly competitive market, achieved remarkable results and covered its product sales network Large and medium-sized cities in China have been widely used in engineering.

In terms of intelligence and informatization, we continue to surpass. In the process of developing humanized products, we spare no effort to make the products of SINGI spread all over the world Every corner is our highest goal.



部分合作伙伴 Some of the partners



## 目录

### Catalogue

---

#### 照明配电箱

GNB-10(全塑)系列	GNB-10系列	GNB-N10系列	GNB-30系列	GNB-N30系列	GNB-N31系列	GNB-50系列	GNB-N50系列	GNB-60系列	GNB-N70(全铁)系列	PZ30系列	GNB F01系列
--------------	----------	-----------	----------	-----------	-----------	----------	-----------	----------	---------------	--------	-----------

#### DISTRIBUTION BOX

GNB-10(all-plastic) series	GNB-10 series	GNB-N10 series	GNB-30 series	GNB-N30 series	GNB-N31 series	GNB-50 series	GNB-N50 series	GNB-60 series	GNB-N70(All iron) series	PZ30 series	GNB F01 series
07-08	09-10	11-12	13-14	15-16	17-18	19-20	21-22	23-24	25-26	27-28	29-30

#### 光纤信息箱

GNZ-G0系列	GNZ-G1系列	GNZ-G2系列	GNZ-G5系列	GNZ-GP2系列	GNZ-708GL2系列	GNZ-GH2系列	GNZ-GF2(全铁)系列	GNZ-GF3(全铁)系列	GNZ-GF5(全铁)系列	GNZ-GF6(全铁)系列	GNZ-208T(全铁)系列
----------	----------	----------	----------	-----------	--------------	-----------	---------------	---------------	---------------	---------------	----------------

#### FIBER OPTIC BOX

GNZ-G0 series	GNZ-G1 series	GNZ-G2 series	GNZ-G5 series	GNZ-GP2 series	GNZ-708GL2 series	GNZ-GH2 series	GNZ-GF2(All iron) series	GNZ-GF3(All iron) series	GNZ-GF5(All iron) series	GNZ-GF6(All iron) series	GNZ-208T(All iron) series
31-32	31-32	31-32	33-34	35-36	37-38	39-40	41-42	41-42	41-42	41-42	43-44

# SINGI<sup>®</sup>

## GNB-10 (全塑)系列配电箱

GNB-10 (all plastic) series  
Distribution Box





## 设计亮点 DESIGN HIGHLIGHTS



采用简洁弧面型面板设计,和墙体契合度高,更优美,高雅。

Adopting a simple curved panel design, it fits well with the wall, making it more beautiful and elegant.



可拆卸挡板设计,可自由调整回路数,有效隔绝大颗粒尘埃的进入。

The detachable baffle design allows for free adjustment of the number of circuits, effectively isolating the entry of large particles of dust.



轻巧的箱门开启方式,一按即开,更方便。

Lightweight box door opening method, easy to open with just one press, more convenient.



可调卡槽设计,通过可调卡槽调节导轨的深度。

Adjustable card slot design, which adjusts the depth of the guide rail through the adjustable card slot.

## 参数信息 PARAMETER INFORMATION

	型号 Type	回路 Loop	面盖 Top cover	底箱 bottom box	暗装安装尺寸 Mounting size (WxHxDmm)	明装安装尺寸 Surface mounted (WxHxDmm)	装箱数 Number of boxes packed		
单排 single row	GNB-1004(all-plastic)	4	ABS、PS	ABS	112x200x66	110x200x90	30		
	GNB-1006(all-plastic)	6			151x200x66	148x200x90	30		
	GNB-1008(all-plastic)	8			185x200x66	182x200x90	30		
	GNB-1010(all-plastic)	10			222x200x66	222x200x90	20		
	GNB-1012(all-plastic)	12			259x200x66	255x200x90	20		
	GNB-1015(all-plastic)	15			315x200x66	310x200x90	15		
	GNB-1018(all-plastic)	18			368x221x76	364x221x94	10		
双排 double rows	GNB-1024(all-plastic)	24					258x312x76	256x326x94	10
三排 three rows	GNB-1036(all-plastic)	36					255x445x76	271x326x100	10
	GNB-1045(all-plastic)	45					312x454x76	325x472x100	5

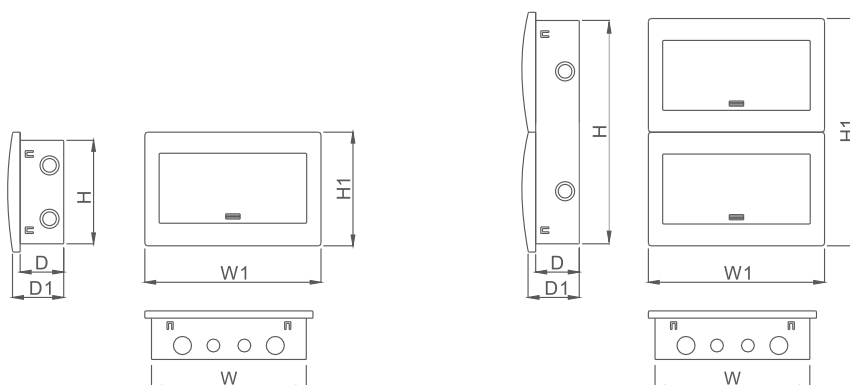

# SINGI<sup>®</sup>

## GNB-10 系列配电箱

GNB-10 series  
Distribution Box



## 设计亮点 DESIGN HIGHLIGHTS



采用简洁弧面型面板设计,和墙体契合度高,更优美,高雅。

Adopting a simple curved panel design, it fits well with the wall, making it more beautiful and elegant.



外延式导轨设计,具有升降调节的功能,可通过固定螺丝调整,使挂钩和墙面保持吻合。

The extended guide rail design has the function of lifting and adjusting, which can be adjusted by fixing screws to keep the hook and wall in line.



轻巧的箱门开启方式,一按即开,更方便。

Lightweight box door opening method, easy to open with just one press, more convenient.



底箱组件含U型导轨组件,零、地排端子组件,接地螺丝等。

The bottom box component includes U-shaped guide rail components, zero and ground terminal components, grounding screws, etc.

## 参数信息 PARAMETER INFORMATION

	型号 Type	回路 Loop	面盖 Top cover	底箱 bottom box	安装尺寸 Mounting size (WxHxDmm)	外形尺寸 Overall dimensions (WxHxDmm)	地排数量 Number of grounding terminals	零排数量 Number of zero line terminals
单排 single row	GNB-1004	4	ABS、PC	冷轧钢板 (0.8mm)  Cold rolled steel plate (0.8mm)	120x140x77	140x160x88	0	4
	GNB-1006	6			175x190x80	198x210x95	4	5
	GNB-1009	9			231x190x80	255x210x95	4	5
	GNB-1013	13			303x190x80	325x210x95	9	2x5
	GNB-1015	15			335x190x80	360x210x95	9	2x5
	GNB-1018	18			387x190x80	415x210x95	9	10+5
双排 double rows	GNB-1026	26		冷轧钢板 (1.0mm)	303x395x80	325x425x95	9	2x10
	GNB-1030	30			335x395x80	360x425x95	9	2x10
	GNB-1036	36			387x395x80	415x425x95	2x9	2x10+5
三排 three rows	GNB-1045	45		冷轧钢板 (1.0mm)	335x610x80	360x630x95	2x9	2x10+4x5
	GNB-1054	54			387x610x80	415x630x95	2x9	2x10+5x5
四排 four rows	GNB-1072	72			387x820x80	415x840x95	2x9	2x10+7x5

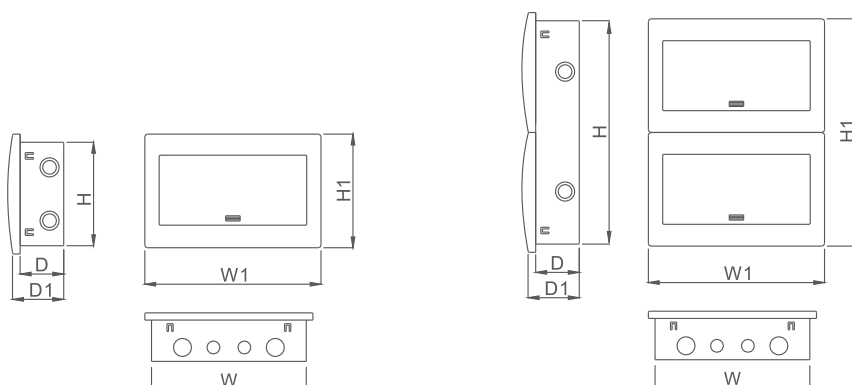

# SINGI<sup>®</sup>

## GNB-N10 系列配电箱

GNB-N10 series  
Distribution Box

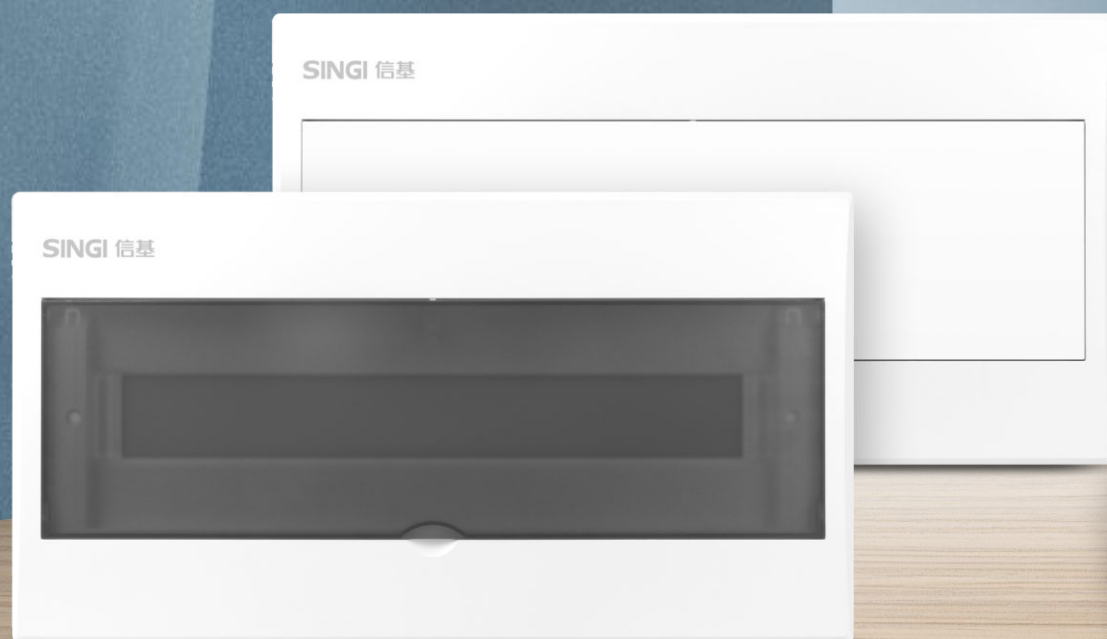

## 设计亮点

## DESIGN HIGHLIGHTS



采用简洁弧面型面板设计, 和墙体契合度高, 更优美, 高雅。

Adopting a simple curved panel design, it fits well with the wall, making it more beautiful and elegant.



外延式导轨设计, 具有升降调节的功能, 可通过固定螺丝调整, 使挂钩和墙面保持吻合。

The extended guide rail design has the function of lifting and adjusting, which can be adjusted by fixing screws to keep the hook and wall in line.



轻巧的箱门开启方式

Lightweight box door opening method



底箱组件含U型导轨组件, 零、地排端子组件, 接地螺丝等。

The bottom box component includes U-shaped guide rail components, zero and ground terminal components, grounding screws, etc.

## 参数信息

## PARAMETER INFORMATION

型号 Type	回路 Loop	面盖 Top cover	底箱 bottom box	安装尺寸 Mounting size (WxHxDmm)	外形尺寸 Overall dimensions (WxHxDmm)	地排数量 Number of grounding terminals	零排数量 Number of zero line terminals
GNB-N1024	24	ABS、PC	冷轧钢板 (0.8mm) Cold rolled steel plate (0.8mm)	496x210x90	518x240x95	8	17

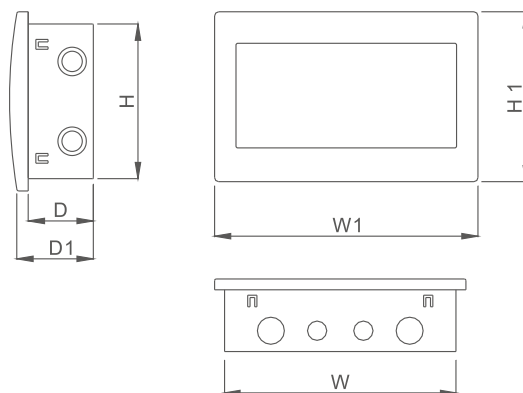

# SINGI<sup>®</sup>

## GNB-30 系列配电箱

GNB-30 series  
Distribution Box



## 设计亮点

## DESIGN HIGHLIGHTS



轻巧的箱门开启方式，一按即开，更方便。

Lightweight box door opening method, easy to open with just one press, more convenient.



外延式导轨设计，具有升降调节的功能，可通过固定螺丝调整，使挂钩和墙面保持吻合。

The extended guide rail design has the function of lifting and adjusting, which can be adjusted by fixing screws to keep the hook and wall in line.



采用双环敲落孔设计，能更好兼容市面上的PVC管。

Adopting a double ring knockout hole design, it can be better compatible with PVC pipes on the market.



底箱组件含U型导轨组件，零、地排端子组件，接地螺丝等。

The bottom box component includes U-shaped guide rail components, zero and ground terminal components, grounding screws, etc.

## 参数信息

## PARAMETER INFORMATION

	型号 Type	回路 Loop	面盖 Top cover	底箱 bottom box	安装尺寸 Mounting size (WxHxDmm)	外形尺寸 Overall dimensions (WxHxDmm)	地排数量 Number of grounding terminals	零排数量 Number of zero line terminals
单排 single row	GNB-3004	4	ABS、PC	冷轧钢板 (0.8mm)	138x154x80	148x174x90	0	5
	GNB-3007	7			189x200x80	210x220x90	4	5
	GNB-3010	10			243x200x80	264x220x90	4	5
	GNB-3013	13			297x200x80	318x220x90	9	10
	GNB-3015	15			333x200x80	354x220x90	9	10
	GNB-3018	18			387x200x80	408x220x90	9	10+5
	GNB-3021	21			441x200x80	462x220x90	9	10+2x5
GNB-3020	20	243x420x80		264x440x90	9	10+2x5		
双排 double rows	GNB-3026	26		冷轧钢板 (1.0mm)	297x420x80	318x440x90	9+4	2x10
	GNB-3030	30			333x420x80	354x440x90	9+4	2x10+5
	GNB-3036	36			387x420x80	408x440x90	9+4	3x10
	GNB-3042	42			441x420x80	460x440x90	2x9	3x10
三排 three rows	GNB-3039	39		冷轧钢板 (1.0mm)	298x640x80	318x660x90	2x9	10+4x5
	GNB-3045	45			334x640x80	354x660x90	2x9	10+4x5
	GNB-3054	54	388x640x80		408x660x90	3x9	10+4x10	
四排 four rows	GNB-3072	72		388x860x80	408x880x90	3x9	10+6x10	

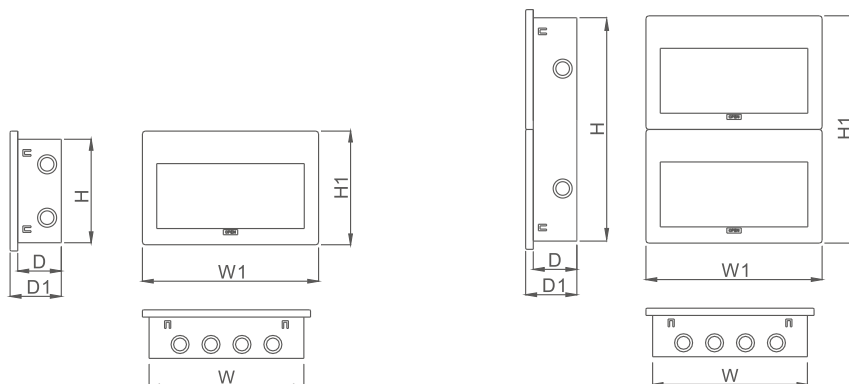

**SINGI**<sup>®</sup>

## **GNB-N30** 系列配电箱

GNB-N30 series  
Distribution Box





## 设计亮点

## DESIGN HIGHLIGHTS



轻巧的箱门开启方式,开、关方便,透明面盖,内部一目了然。

The lightweight opening method of the box door makes it easy to open and close, and the transparent cover makes the interior clear at a glance.



外延式导轨设计,具有升降调节的功能,可通过固定螺丝调整,使挂钩和墙面保持吻合。

The extended guide rail design has the function of lifting and adjusting, which can be adjusted by fixing screws to keep the hook and wall in line.

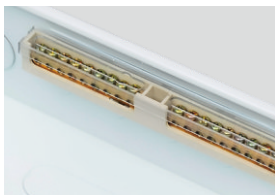

优质铜排,导电性强,耐磨损的特性,降低安全风险。

Adopting a double ring knockout hole design, it can be better compatible with PVC pipes on the market.

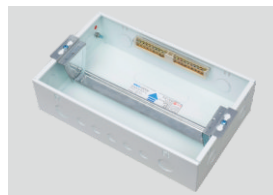

底箱组件含U型导轨组件,零、地排端子组件,接地螺丝等。

The bottom box component includes U-shaped guide rail components, zero and ground terminal components, grounding screws, etc.

## 参数信息

## PARAMETER INFORMATION

	型号 Type	回路 Loop	面盖 Top cover	底箱 bottom box	安装尺寸 Mounting size (WxHxDmm)	外形尺寸 Overall dimensions (WxHxDmm)	地排数量 Number of grounding terminals	零排数量 Number of zero line terminals
单排 single row	GNB-N3009	9	ABS、PC	冷轧钢板 (0.8mm)	232x210x80	252x230x95	8	9
	GNB-N3013	13			304x210x80	324x230x95	8	9
	GNB-N3015	15			340x210x80	360x230x95	8	9
	GNB-N3018	18			394x210x80	414x230x95	8	13
	GNB-N3022	22			466x210x80	486x230x95	8	17
双排 double rows	GNB-N3026	26		冷轧钢板 (1.0mm)	304x440x80	324x460x95	2x8	2x9
	GNB-N3030	30			340x440x80	360x460x95	2x8	2x9
	GNB-N3036	36			394x440x80	414x460x95	2x8	2x17
	GNB-N3044	44			466x440x80	486x460x95	2x8	2x17
三排 three rows	GNB-N3045	45		冷轧钢板 (1.0mm)	340x670x80	360x690x95	2x8	2x17
	GNB-N3054	54			394x670x80	414x690x95	2x8	2x17
	GNB-N3066	66	466x670x80		486x690x95	2x8	2x17	

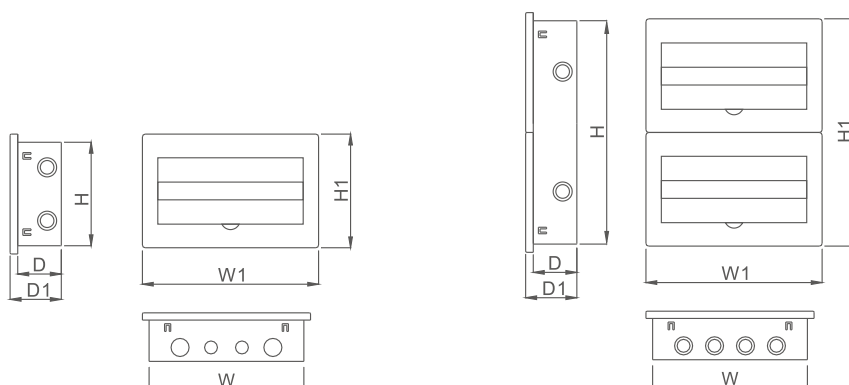

# SINGI<sup>®</sup>

## GNB-N31 系列配电箱

GNB-N31 series  
Distribution Box



## 设计亮点

## DESIGN HIGHLIGHTS



轻巧的箱门开启方式,开、关方便。  
Lightweight box door opening method, easy to open and close.



外延式导轨设计,具有升降调节的功能,可通过固定螺丝调整,使挂钩和墙面保持吻合。

The extended guide rail design has the function of lifting and adjusting, which can be adjusted by fixing screws to keep the hook and wall in line.

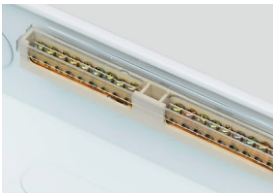

优质铜排,导电性强,耐磨损的特性,降低安全风险。  
Adopting a double ring knockout hole design, it can be better compatible with PVC pipes on the market.

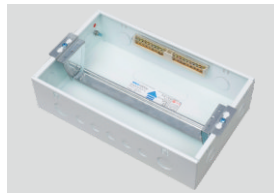

底箱组件含U型导轨组件,零、地排端子组件,接地螺丝等。

The bottom box component includes U-shaped guide rail components, zero and ground terminal components, grounding screws, etc.

## 参数信息

## PARAMETER INFORMATION

	型号 Type	回路 Loop	面盖 Top cover	底箱 bottom box	安装尺寸 Mounting size (WxHxDmm)	外形尺寸 Overall dimensions (WxHxDmm)	地排数量 Number of grounding terminals	零排数量 Number of zero line terminals
单排 single row	GNB-N3109	9	ABS、PC	冷轧钢板 (0.8mm)	232x210x80	252x230x95	8	9
	GNB-N3113	13			304x210x80	324x230x95	8	9
	GNB-N3115	15			340x210x80	360x230x95	8	9
	GNB-N3118	18			394x210x80	414x230x95	8	13
	GNB-N3122	22			466x210x80	486x230x95	8	17
分体式双排 Split double row	GNB-N3126	26		冷轧钢板 (1.0mm)	304x440x80	324x460x95	2x8	2x9
一体式双排 Integrated double row	GNB-N3130	30			340x400x90	360x420x104	2x8	2x9
	GNB-N3136	36			394x400x90	414x420x104	2x8	2x17
	GNB-N3144	44			466x400x90	486x420x104	2x8	2x17
三排 three rows	GNB-N3145	45			冷轧钢板 (1.0mm)	340x670x80	360x690x95	2x8
	GNB-N3154	54		394x670x80		414x690x95	2x8	2x17
	GNB-N3166	66	466x670x80	486x690x95		2x8	2x17	

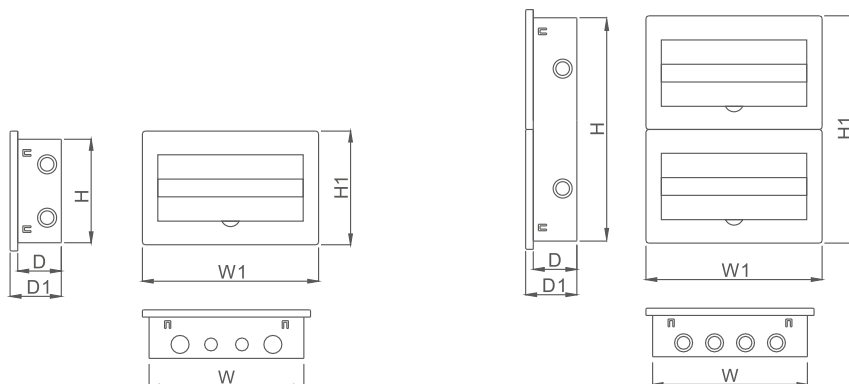

# SINGI<sup>®</sup>

## GNB-50 系列配电箱

GNB-50 series  
Distribution Box



## 设计亮点

## DESIGN HIGHLIGHTS



轻巧的箱门开启方式,开、关方便,透明面盖,内部一目了然。

The lightweight opening method of the box door makes it easy to open and close, and the transparent cover makes the interior clear at a glance.



导轨组件具有升降调节的功能,可通过固定螺丝调整。

The guide rail component has the function of lifting and adjusting, which can be adjusted by fixing screws.



优质铜排,导电性强,耐磨损的特性,降低安全风险。

Adopting a double ring knockout hole design, it can be better compatible with PVC pipes on the market.



底箱组件含U型导轨组件,零、地排端子组件,接地螺丝等。

The bottom box component includes U-shaped guide rail components, zero and ground terminal components, grounding screws, etc.

## 参数信息

## PARAMETER INFORMATION

	型号 Type	回路 Loop	面盖 Top cover	底箱 bottom box	安装尺寸 Mounting size (WxHxDmm)	外形尺寸 Overall dimensions (WxHxDmm)	地排数量 Number of grounding terminals	零排数量 Number of zero line terminals
单排 single row	GNB-5008	8	ABS、PC	冷轧钢板 (0.8mm)	222x210x80	250x230x105	4	5
	GNB-5012	12			290x220x80	315x250x105	9	2x5
	GNB-5016	16			363x220x80	390x250x105	9	2x5
	GNB-5020	20			435x220x80	460x250x105	9	10+5
双排 double rows	GNB-5024	24		冷轧钢板 (1.0mm)	290x370x80	315x400x105	9	2x10
	GNB-5032	32		冷轧钢板 (1.0mm)	363x470x80	390x500x105	2x9	2x10+5
	GNB-5040	40			435x470x80	460x500x105	2x9	2x10+5

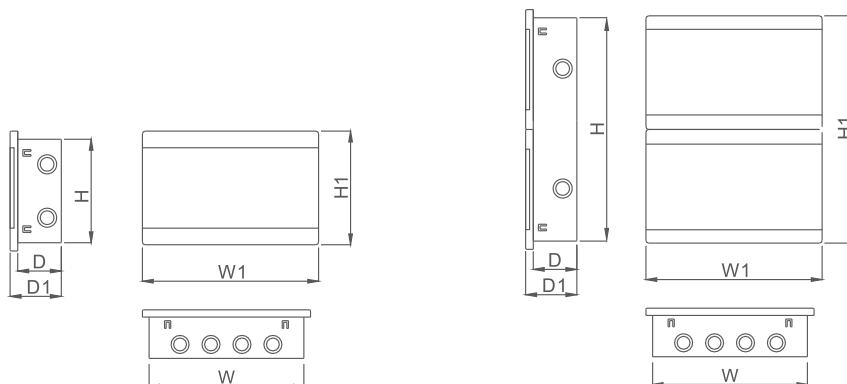

# SINGI<sup>®</sup>

## GNB-N50 系列配电箱

GNB-N50 series  
Distribution Box



## 设计亮点

## DESIGN HIGHLIGHTS



无边框设计，上下开启方式，透明面盖，内部一目了然。  
Borderless design, open up and down, transparent cover, and clear interior.

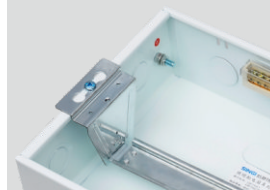

外延式导轨设计，具有升降调节的功能，可通过固定螺丝调整，使挂钩和墙面保持吻合。

The extended guide rail design has the function of lifting and adjusting, which can be adjusted by fixing screws to keep the hook and wall in line.

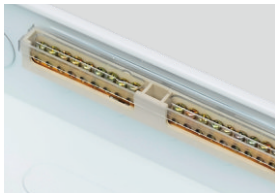

优质铜排，导电性强，耐磨损的特性，降低安全风险。  
Adopting a double ring knockout hole design, it can be better compatible with PVC pipes on the market.

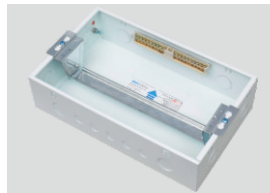

底箱组件含U型导轨组件，零、地排端子组件，接地螺丝等。

The bottom box component includes U-shaped guide rail components, zero and ground terminal components, grounding screws, etc.

## 参数信息

## PARAMETER INFORMATION

	型号 Type	回路 Loop	面盖 Top cover	底箱 bottom box	安装尺寸 Mounting size (WxHxDmm)	外形尺寸 Overall dimensions (WxHxDmm)	地排数量 Number of grounding terminals	零排数量 Number of zero line terminals
单排 single row	GNB-N5008	8	ABS、PC	冷轧钢板 (1.0mm)  Cold rolled steel plate (1.0mm)	214x210x90	334x230x105	6	7
	GNB-N5012	12			286x220x90	306x250x105	8	9
	GNB-N5016	16			358x220x90	378x250x105	8	13
	GNB-N5020	20			430x220x90	450x250x105	8	13
双排 double rows	GNB-N5024	24			286x400x90	316x430x110	2x8	2x9
	GNB-N5030	32			340x400x90	370x430x110	2x8	2x9
	GNB-N5040	40			430x470x90	450x500x105	2x8	2x17

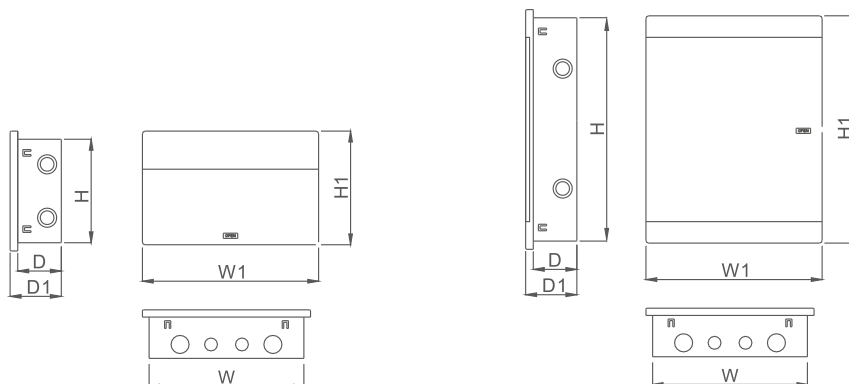

# SINGI<sup>®</sup>

## GNB-60 系列配电箱

GNB-60 series  
Distribution Box





## 设计亮点

## DESIGN HIGHLIGHTS



轻巧的箱门开启方式,开、关方便。  
Lightweight box door opening method, easy to open and close.



外延式导轨设计,具有升降调节的功能,可通过固定螺丝调整,使挂钩和墙面保持吻合。

The extended guide rail design has the function of lifting and adjusting, which can be adjusted by fixing screws to keep the hook and wall in line.



优质铜排,导电性强,耐磨损的特性,降低安全风险。

Adopting a double ring knockout hole design, it can be better compatible with PVC pipes on the market.



底箱组件含U型导轨组件,零、地排端子组件,接地螺丝等。

The bottom box component includes U-shaped guide rail components, zero and ground terminal components, grounding screws, etc.

## 参数信息

## PARAMETER INFORMATION

	型号 Type	回路 Loop	面盖 Top cover	底箱 bottom box	安装尺寸 Mounting size (WxHxDmm)	外形尺寸 Overall dimensions (WxHxDmm)	地排数量 Number of grounding terminals	零排数量 Number of zero line terminals
单排 single row	GNB-6008	8	ABS、PC	冷轧钢板 (0.8mm)	201x190x85	223x206x105	10	10
	GNB-6012	12			273x210x85	295x226x105	10	10
	GNB-6016	16			345x210x85	367x226x105	14	14
	GNB-6020	20			417x210x85	439x226x105	14	14
双排 double rows	GNB-6024	24		冷轧钢板 (1.0mm)	273x436x85	295x452x105	2x10	2x10
	GNB-6032	32			345x436x85	367x452x105	2x14	2x14
	GNB-6040	40			417x436x85	439x452x105	2x14	2x14
三排 three rows	GNB-6048	48		冷轧钢板 (1.0mm)	345x662x85	367x678x105	2x14	2x14+4x10
	GNB-6060	60	417x662x85		439x678x105	2x14	2x14+4x10	

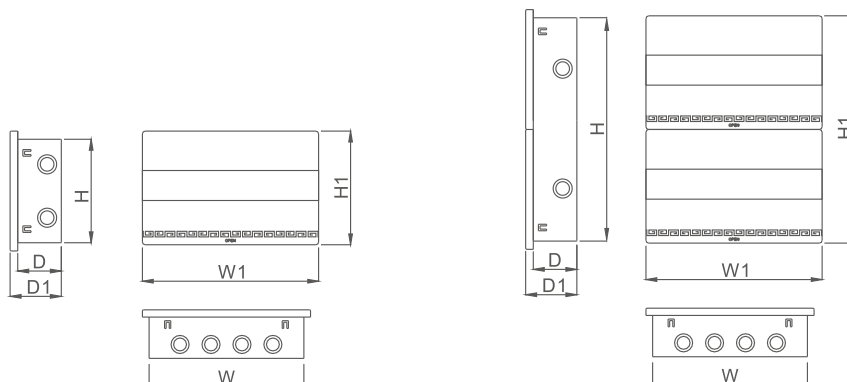

# SINGI<sup>®</sup>

## GNB-N70 (全铁)系列配电箱

GNB-N70(All iron) series  
Distribution Box



## 设计亮点

## DESIGN HIGHLIGHTS

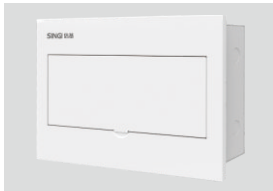

纯平全铁面盖设计，上下开启方式，开、关方便。

Pure flat full iron cover design with up and down opening method, Convenient opening and closing.

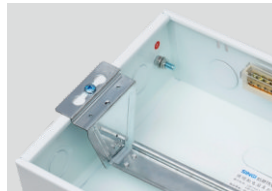

外延式导轨设计，具有升降调节的功能，可通过固定螺丝调整，使挂钩和墙面保持吻合。

The extended guide rail design has the function of lifting and adjusting, which can be adjusted by fixing screws to keep the hook and wall in line.

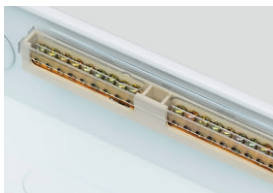

优质铜排，导电性强，耐磨损的特性，降低安全风险。

Adopting a double ring knockout hole design, it can be better compatible with PVC pipes on the market.

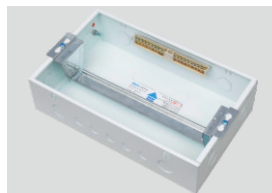

底箱组件含U型导轨组件，零、地排端子组件，接地螺丝等。

The bottom box component includes U-shaped guide rail components, zero and ground terminal components, grounding screws, etc.

## 参数信息

## PARAMETER INFORMATION

	型号 Type	回路 Loop	面盖 Top cover	底箱 bottom box	安装尺寸 Mounting size (WxHxDmm)	外形尺寸 Overall dimensions (WxHxDmm)	地排数量 Number of grounding terminals	零排数量 Number of zero line terminals
单排 single row	GNB-N7012	12	冷轧钢板 (1.0mm)	冷轧钢板 (1.0mm)	278x220x90	318x250x100	8	9
	GNB-N7016	16			350x220x90	390x250x100	8	13
	GNB-N7020	20			422x220x90	462x250x100	8	13
双排 double rows	GNB-N7024	24			278x410x90	318x440x100	2x8	2x9
	GNB-N7032	32			350x410x90	390x440x100	2x8	2x9
	GNB-N7040	40			422x410x90	462x440x100	2x8	2x17
三排 three rows	GNB-N7048	48			350x600x90	390x630x100	2x8	2x17
	GNB-N7060	60	422x600x90	462x630x100	2x8	2x17		

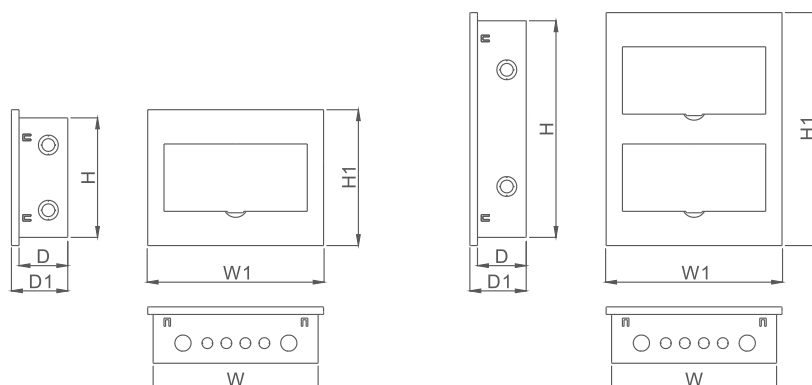

# SINGI<sup>®</sup>

## PZ30 系列配电箱

PZ30 series  
Distribution Box



## 设计亮点

## DESIGN HIGHLIGHTS



轻巧的箱门开启方式,开、关方便,透明面盖,内部一目了然。

The lightweight opening method of the box door makes it easy to open and close, and the transparent cover makes the interior clear at a glance.



导轨组件具有升降调节的功能,可通过固定螺丝调整。

The guide rail component has the function of lifting and adjusting, which can be adjusted by fixing screws.



优质铜排,导电性强,耐磨损的特性,降低安全风险。

Adopting a double ring knockout hole design, it can be better compatible with PVC pipes on the market.

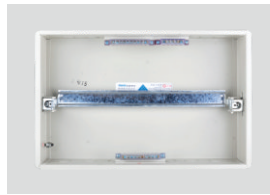

底箱组件含U型导轨组件,零、地排端子组件,接地螺丝等。

The bottom box component includes U-shaped guide rail components, zero and ground terminal components, grounding screws, etc.

## 参数信息

## PARAMETER INFORMATION

	型号 Type	回路 Loop	面盖 Top cover	底箱 bottom box	安装尺寸 Mounting size (WxHxDmm)	外形尺寸 Overall dimensions (WxHxDmm)	地排数量 Number of grounding terminals	零排数量 Number of zero line terminals
单排 single row	PZ30-4	4	冷轧钢板 +PS  Cold rolled steel plate +PS	冷轧钢板 (0.8mm)  Cold rolled steel plate (0.8mm)	135x145x80	165x175x90	0	5
	PZ30-6	6			161x210x90	202x250x100	4	5
	PZ30-8	8			195x260x90	238x300x100	4	5
	PZ30-10	10			233x260x90	272x300x100	4	5
	PZ30-12	12			269x260x90	310x300x100	9	2x5
	PZ30-15	15			325x260x90	365x300x100	9	2x5
	PZ30-18	18			380x260x90	420x300x100	9	10+5
	PZ30-20	20			414x260x90	454x300x100	9	10+5
双排 double rows	PZ30-24	24	冷轧钢板 (1.0mm)  Cold rolled steel plate (1.0mm)	490x260x90	530x300x100	9	2x10	
	PZ30-24	24		269x460x90	310x500x100	9	2x10	
	PZ30-30	30		325x460x90	365x500x100	9	2x10	
	PZ30-36	36		380x460x90	420x500x100	2x9	2x10+5	
三排 three rows	PZ30-40	40	冷轧钢板 (1.0mm)  Cold rolled steel plate (1.0mm)	414x460x90	454x500x100	2x9	2x10+5	
	PZ30-45	45		325x660x90	365x700x100	2x9	10+4x10	
	PZ30-54	54		380x660x90	420x700x100	2x9	2x10+4x10	

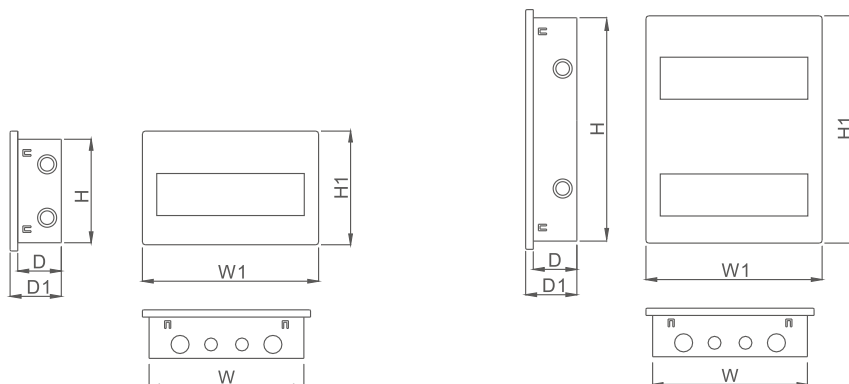

# SINGI<sup>®</sup>

## GNB F01 系列防水配电箱

GNB F01 series  
Waterproof Distribution  
Box



## 设计亮点

## DESIGN HIGHLIGHTS



轻巧的箱门开启方式,开、关方便,透明面盖,内部一目了然。

The lightweight opening method of the box door makes it easy to open and close, and the transparent cover makes the interior clear at a glance.



IP67防护等级,一体成型防水密封条,耐腐蚀,抗老化

IP67 protection grade, integrated waterproof sealing strip, corrosion resistance and aging resistance



双排紫铜接线端子,增加进线面积  
Double row copper terminal blocks to increase the incoming area



底箱组件含U型导轨组件,零、地排端子组件等。

The bottom box component includes U-shaped guide rail components, zero and ground terminal components, etc.

## 参数信息

## PARAMETER INFORMATION

型号 Type	回路 Loop	材质 material quality			安装孔距 Installation hole spacing (W2xLmm)	外形尺寸 Overall dimensions (W1xDxHmm)	线缆接口 Cable interface	
		面盖 Top cover	面框/底箱 Face frame/bottom box	接线端子 Terminal blocks			箱体上方 Above the box(mm)	箱体下方 Under the box(mm)
GNB F01-4	4	PC	PC+ABS	黄铜 Brass	88x150	129x102x200	2xφ22	2xφ22
GNB F01-6	6				124x150	165x102x200	2xφ22 1xφ32	2xφ22 1xφ32
GNB F01-9	9				170x150	219x102x200	2xφ22 2xφ32	2xφ22 2xφ32
GNB F01-12	12				220x170	270x102x220	2xφ22 3xφ32	2xφ22 3xφ32
GNB F01-18	18				300x170	280x112x230	4xφ22 4xφ32	4xφ22 4xφ32

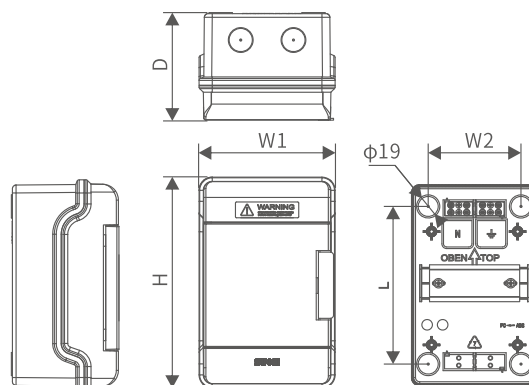

# SINGI®

## GNZ-G0/G1/G2 系列光纤箱

GNZ-G0/G1/G2 series  
Fiber Optic Box





## 设计亮点 DESIGN HIGHLIGHTS



无边框面盖设计, 简洁优雅。  
Borderless cover design, simple and elegant.



可根据实际情况增减模块, 满足对网络、电视、电话、监控等统一管理。  
Modules can be added or removed according to actual situations to meet the unified management of network, television, telephone, monitoring, etc.



为设备提供持久电力, 输出 AC220V, 安全可靠。  
Provide long-lasting power for equipment, output AC220V, safe and reliable.



双层猫支架, 可兼容不同尺寸的路由器和调制解调器。  
Double layer cat stand, compatible with routers and modems of different sizes.

## 参数信息 PARAMETER INFORMATION

型号 Type	面盖 Top cover	底箱 bottom box	安装尺寸 Mounting size (WxHxDmm)	外形尺寸 Overall dimensions (WxHxDmm)	模块容量 Module capacity	电源插座 bottom box	敲落孔 Threading hole
GNZ-G0	ABS	冷轧钢板 (0.8mm) Cold rolled steel plate (0.8mm)	320x240x100	345x265x140	4U	2位5孔 Two position five hole socket	φ25mm x 18
GNZ-G1			350x300x120	375x325x140	6U		
GNZ-G2			400x300x120	430x325x140	6U		

## 多种模块可选 MULTIPLE MODULES AVAILABLE

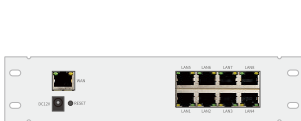

千兆八口有线路由器模块  
Gigabit 8-port wired router module



千兆四口无线路由器模块  
Gigabit 4-port wireless router module

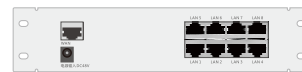

千兆八口交换机模块  
1000M 8-port switch module



电视/电话模块  
TV/Telephone Module



百兆八口有线路由器模块  
100M 8-port wired router module



百兆四口有线路由器模块  
100M 4-port wired router module



百兆八口交换机模块  
100M 8-port switch module



电视模块  
TV module

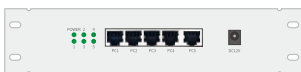

百兆五口交换机模块  
100M 5-port switch module



电源风扇模块  
Power Fan Module



智能风扇模块  
Intelligent fan module



电话模块  
Telephone module



走线模块  
Wiring module

# SINGI<sup>®</sup>

## GNZ-G5 系列光纤箱

GNZ-G5 series  
Fiber Optic Box



## 设计亮点 DESIGN HIGHLIGHTS

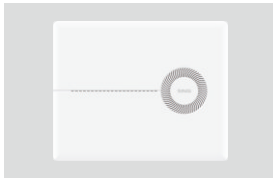

无边框面盖设计, 简洁优雅。  
Borderless cover design, simple and elegant.



可根据实际情况增减模块, 满足对网络、电视、电话、监控等统一管理。  
Modules can be added or removed according to actual situations to meet the unified management of network, television, telephone, monitoring, etc.



为设备提供持久电力, 输出 AC220V, 安全可靠。  
Provide long-lasting power for equipment, output AC220V, safe and reliable.

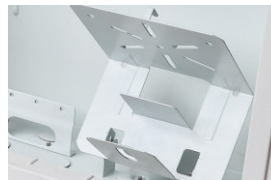

双层猫支架, 可兼容不同尺寸的路由器和调制解调器。  
Double layer cat stand, compatible with routers and modems of different sizes.

## 参数信息 PARAMETER INFORMATION

型号 Type	面盖 Top cover	底箱 bottom box	安装尺寸 Mounting size (WxHxDmm)	外形尺寸 Overall dimensions (WxHxDmm)	模块容量 Module capacity	电源插座 bottom box	敲落孔 Threading hole
GNZ-G5	ABS	冷轧钢板 (1.0mm) Cold rolled steel plate (1.0mm)	500x400x120	530x425x138.5	14U	2位5孔 Two position five hole socket	φ25mm x50

## 多种模块可选 MULTIPLE MODULES AVAILABLE

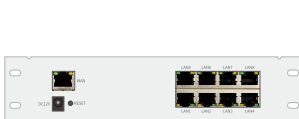

千兆八口有线路由器模块  
Gigabit 8-port wired router module



千兆四口无线路由器模块  
Gigabit 4-port wireless router module

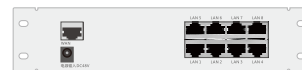

千兆八口交换机模块  
1000M 8-port switch module



电视/电话模块  
TV/Telephone Module



百兆八口有线路由器模块  
100M 8-port wired router module



百兆四口有线路由器模块  
100M 4-port wired router module



百兆八口交换机模块  
100M 8-port switch module



电视模块  
TV module



百兆五口交换机模块  
100M 5-port switch module



电源风扇模块  
Power Fan Module



智能风扇模块  
Intelligent fan module



电话模块  
Telephone module



走线模块  
Wiring module

# SINGI<sup>®</sup>

## GNZ-GP2 系列光纤箱

GNZ-GP2 series  
Fiber Optic Box



## 设计亮点 DESIGN HIGHLIGHTS

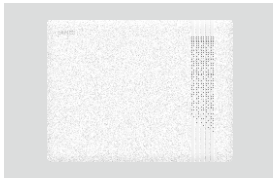

无边框钢化玻璃面盖设计, 简洁优雅。  
The frameless tempered glass cover design is simple and elegant.



可根据实际情况增减模块, 满足对网络、电视、电话、监控等统一管理。  
Modules can be added or removed according to actual situations to meet the unified management of network, television, telephone, monitoring, etc.



为设备提供持久电力, 输出 AC220V, 安全可靠。  
Provide long-lasting power for equipment, output AC220V, safe and reliable.

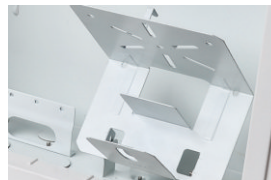

双层猫支架, 可兼容不同尺寸的路由器和调制解调器。  
Double layer cat stand, compatible with routers and modems of different sizes.

## 参数信息 PARAMETER INFORMATION

型号 Type	面盖 Top cover	底箱 bottom box	安装尺寸 Mounting size (WxHxDmm)	外形尺寸 Overall dimensions (WxHxDmm)	模块容量 Module capacity	电源插座 bottom box	敲落孔 Threading hole
GNZ-GP2	ABS	冷轧钢板 (0.8mm) Cold rolled steel plate (0.8mm)	400x300x120	430x325x140	6U	2位5孔 Two position five hole socket	φ25mm x 22

## 多种模块可选 MULTIPLE MODULES AVAILABLE

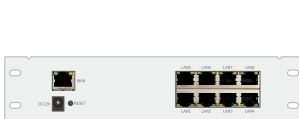

千兆八口有线路由器模块  
Gigabit 8-port wired router module



千兆四口无线路由器模块  
Gigabit 4-port wireless router module

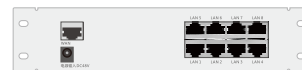

千兆八口交换机模块  
1000M 8-port switch module



电视/电话模块  
TV/Telephone Module



百兆八口有线路由器模块  
100M 8-port wired router module



百兆四口有线路由器模块  
100M 4-port wired router module



百兆八口交换机模块  
100M 8-port switch module



电视模块  
TV module



百兆五口交换机模块  
100M 5-port switch module



电源风扇模块  
Power Fan Module



智能风扇模块  
Intelligent fan module



电话模块  
Telephone module



走线模块  
Wiring module

# SINGI<sup>®</sup>

## GNZ-708GL2 系列光纤箱

GNZ-708GL2 series  
Fiber Optic Box



## 设计亮点 DESIGN HIGHLIGHTS



采用模块化设计,符合市面上230mm长度的标准模块。  
Adopting modular design, meeting the standard module length of 230mm on the market.



可根据实际情况增减模块,满足对网络、电视、电话、监控等统一管理。  
Modules can be added or removed according to actual situations to meet the unified management of network, television, telephone, monitoring, etc.



为设备提供持久电力,输出AC220V,安全可靠。  
Provide long-lasting power for equipment, output AC220V, safe and reliable.

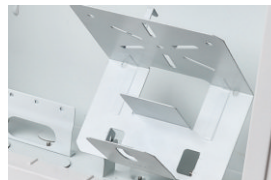

双层猫支架,可兼容不同尺寸的路由器和调制解调器。  
Double layer cat stand, compatible with routers and modems of different sizes.

## 参数信息 PARAMETER INFORMATION

型号 Type	面盖 Top cover	底箱 bottom box	安装尺寸 Mounting size (WxHxDmm)	外形尺寸 Overall dimensions (WxHxDmm)	模块容量 Module capacity	电源插座 bottom box	敲落孔 Threading hole
GNZ-708GL2	ABS	冷轧钢板 (0.8mm) Cold rolled steel plate (0.8mm)	400x300x120	425x325x140	6U	2位5孔 Two position five hole socket	φ25mm x 22

## 多种模块可选 MULTIPLE MODULES AVAILABLE

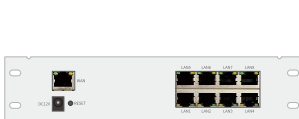

千兆八口有线路由器模块  
Gigabit 8-port wired router module



千兆四口无线路由器模块  
Gigabit 4-port wireless router module

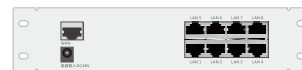

千兆八口交换机模块  
1000M 8-port switch module



电视/电话模块  
TV/Telephone Module



百兆八口有线路由器模块  
100M 8-port wired router module



百兆四口有线路由器模块  
100M 4-port wired router module



百兆八口交换机模块  
100M 8-port switch module



电视模块  
TV module



百兆五口交换机模块  
100M 5-port switch module



电源风扇模块  
Power Fan Module



智能风扇模块  
Intelligent fan module



电话模块  
Telephone module



走线模块  
Wiring module

# SINGI<sup>®</sup>

## GNZ-GH2 钢化玻璃光纤箱

GNZ-GH2 series  
Tempered glass fiber optic box

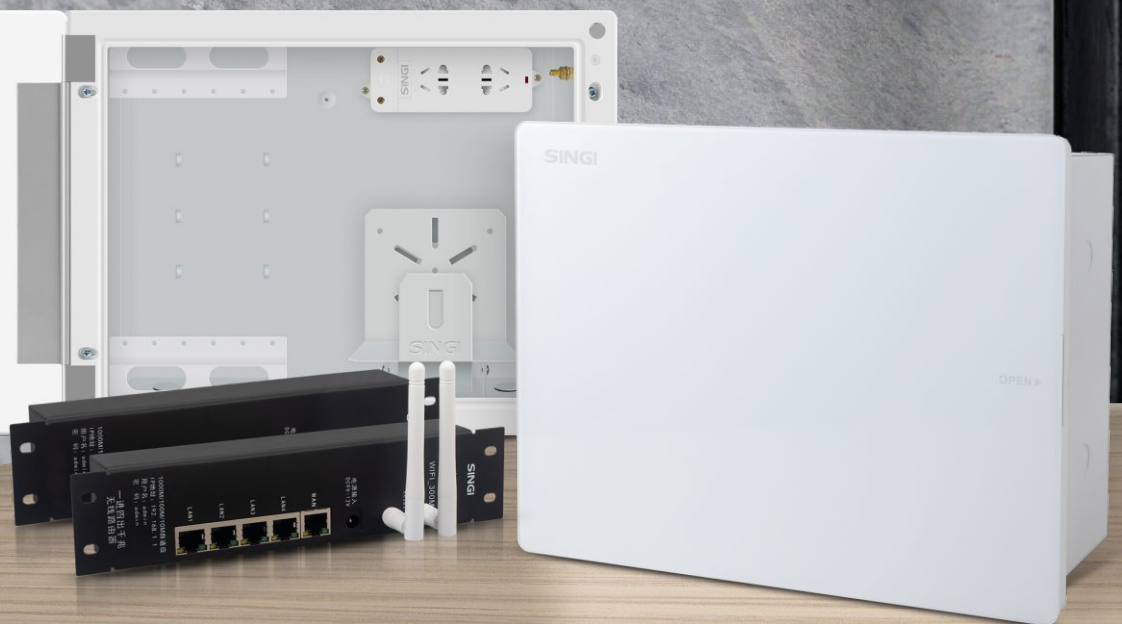



## 设计亮点 DESIGN HIGHLIGHTS



无边框钢化玻璃面盖设计, 简洁优雅。  
The frameless tempered glass cover design is simple and elegant.



可根据实际情况增减模块, 满足对网络、电视、电话、监控等统一管理。  
Modules can be added or removed according to actual situations to meet the unified management of network, television, telephone, monitoring, etc.



为设备提供持久电力, 输出 AC220V, 安全可靠。  
Provide long-lasting power for equipment, output AC220V, safe and reliable.



双层猫支架, 可兼容不同尺寸的路由器和调制解调器。  
Double layer cat stand, compatible with routers and modems of different sizes.

## 参数信息 PARAMETER INFORMATION

型号 Type	面盖 Top cover	底箱 bottom box	安装尺寸 Mounting size (WxHxDmm)	外形尺寸 Overall dimensions (WxHxDmm)	模块容量 Module capacity	电源插座 bottom box	敲落孔 Threading hole
GNZ-GH2	钢化玻璃 (3mm) Armoured glass (3mm)	冷轧钢板 (0.8mm) Cold rolled steel plate (0.8mm)	400x300x120	430x327x137.5	6U	2位5孔 Two position five hole socket	φ25mm x 22

## 多种模块可选 MULTIPLE MODULES AVAILABLE

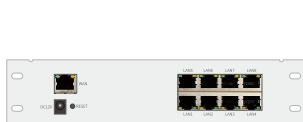

千兆八口有线路由器模块  
Gigabit 8-port wired router module



千兆四口无线路由器模块  
Gigabit 4-port wireless router module



千兆八口交换机模块  
1000M 8-port switch module



电视/电话模块  
TV/Telephone Module



百兆八口有线路由器模块  
100M 8-port wired router module



百兆四口有线路由器模块  
100M 4-port wired router module



百兆八口交换机模块  
100M 8-port switch module



电视模块  
TV module



百兆五口交换机模块  
100M 5-port switch module



电源风扇模块  
Power Fan Module



智能风扇模块  
Intelligent fan module

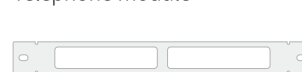

电话模块  
Telephone module

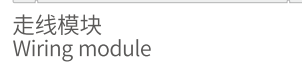

走线模块  
Wiring module

# SINGI<sup>®</sup>

## GNZ-GF (全铁)系列光纤箱

GNZ-GF(All iron) series  
Fiber Optic Box



## 设计亮点 DESIGN HIGHLIGHTS

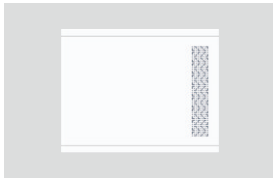

全铁设计, 坚固耐用  
The frameless tempered glass cover design is simple and elegant.



可根据实际情况增减模块, 满足对网络、电视、电话、监控等统一管理。  
Modules can be added or removed according to actual situations to meet the unified management of network, television, telephone, monitoring, etc.



为设备提供持久电力, 输出 AC220V, 安全可靠。  
Provide long-lasting power for equipment, output AC220V, safe and reliable.

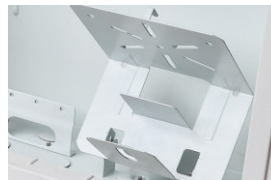

双层猫支架, 可兼容不同尺寸的路由器和调制解调器。  
Double layer cat stand, compatible with routers and modems of different sizes.

## 参数信息 PARAMETER INFORMATION

型号 Type	面盖 Top cover	底箱 bottom box	安装尺寸 Mounting size (WxHxDmm)	外形尺寸 Overall dimensions (WxHxDmm)	模块容量 Module capacity	电源插座 bottom box	敲落孔 Threading hole
GNZ-GF2	冷轧钢板(1.0mm) Cold rolled steel plate (1.0mm)	冷轧钢板(0.8mm) Cold rolled steel plate (0.8mm)	400x300x120	430x340x140	6U	2位5孔 Two position five hole socket	φ25mm x 22
GNZ-GF3			450x300x120	480x340x140	6U		
GNZ-GF5	冷轧钢板(1.0mm) Cold rolled steel plate (1.0mm)	冷轧钢板(1.0mm) Cold rolled steel plate (1.0mm)	500x400x120	530x440x140	14U		φ25mm x 50
GNZ-GF6			600x400x120	630x440x140	14U		

## 多种模块可选 MULTIPLE MODULES AVAILABLE

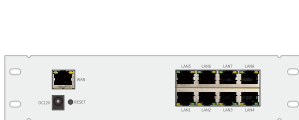

千兆八口有线路由器模块  
Gigabit 8-port wired router module



千兆四口无线路由器模块  
Gigabit 4-port wireless router module

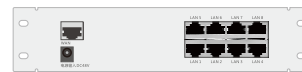

千兆八口交换机模块  
1000M 8-port switch module



电视/电话模块  
TV/Telephone Module



百兆八口有线路由器模块  
100M 8-port wired router module



百兆四口有线路由器模块  
100M 4-port wired router module



百兆八口交换机模块  
100M 8-port switch module



电视模块  
TV module



百兆五口交换机模块  
100M 5-port switch module



电源风扇模块  
Power Fan Module



智能风扇模块  
Intelligent fan module



电话模块  
Telephone module



走线模块  
Wiring module

# SINGI<sup>®</sup>

## GNZ-208T 系列光纤箱

GNZ-208T series  
Fiber Optic Box



## 设计亮点

## DESIGN HIGHLIGHTS



全铁面盖  
All iron cover



简约菱形散热孔, 高效散热  
Simple diamond shaped heat dissipation holes for efficient heat dissipation



门锁卡扣设计, 更加实用  
Door lock buckle design, more practical



7U模块支架  
7U module bracket

## 参数信息

## PARAMETER INFORMATION

型号 Type	面盖 Top cover	底箱 bottom box	安装尺寸 Mounting size (WxHxDmm)	外形尺寸 Overall dimensions (WxHxDmm)	模块容量 Module capacity	敲落孔 Threading hole
GNZ-208T	冷轧钢板(0.8mm) Cold rolled steel plate(0.8mm)		300x200x100	330x220x110	7U	φ20mm x 2 φ25mm x 4 φ32mm x 4

## 多种模块可选

## MULTIPLE MODULES AVAILABLE

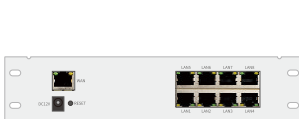

千兆八口有线路由器模块  
Gigabit 8-port wired router module



千兆四口无线路由器模块  
Gigabit 4-port wireless router module

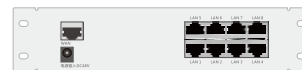

千兆八口交换机模块  
1000M 8-port switch module



电视/电话模块  
TV/Telephone Module



百兆八口有线路由器模块  
100M 8-port wired router module



百兆四口有线路由器模块  
100M 4-port wired router module



百兆八口交换机模块  
100M 8-port switch module



电视模块  
TV module



百兆五口交换机模块  
100M 5-port switch module



电源风扇模块  
Power Fan Module



智能风扇模块  
Intelligent fan module



电话模块  
Telephone module



走线模块  
Wiring module



## 信行天下·基固利他

以诚信服务天下用户，时时改善、夯实基础、认真践行专注、共生、利他的价值观。

Serve users all over the world with integrity, improve and consolidate the foundation from time to time seriously implement the values of focus, symbiosis and altruism

---

### 上海信基电气有限公司

地址: 上海市奉贤区庄行欧洲工业园区航南公路7833号  
电话: 021-63457222 传真: 021-63457577

### SHANGHAI SINGI ELECTRICAL CO. LTD

Add: European Industrial Zone, Zhuanghang, Fengxian District, Shanghai  
Tel : +86-021-63457222 Fax : +86-021-63457577

### 浙江信基电气股份有限公司

地址: 浙江省乐清市经济开发区纬十二路148号东首  
电话: 0577-62773155 0577-62668211  
传真: 0577-62772155 邮编: 325600  
邮箱: singi@188.com 网站: www.singi.cn

### ZHEJIANG SINGI ELECTRICAL LLC

Add : East Of No 148 Wei 12th Road, Yueqing Economic Development Zone, Yueqing City, Zhejiang Province, 325600, China  
Tel : +86-577-62053322 Fax : +86-577-62772155  
Website : www.singi.com E-mail : singi@188.com P.C. : 325600

---